



United States	1-800-653-5350	Canada	905-629-7226
United Kingdom	0800 328 2424	Asia/Pacific	+65-6796-9600
Australia	1-800-672-906	Austria/sterreich	1-505-5794-0
Denmark/Danmark	7020-1718	Finland/Suomi	9 5407 580
France	01-40-96-52-21	Germany/Deutschland	6074-49020
Italy/Italia	2-484441	Mexico/México	5-520-1835
Netherlands/Nederland	315-271700	Norway/Norge	+47 2322 4375
South Africa	11-8095311	Spain/España	91 324 40 00
Sweden/Sverige	84452900	Inside Spain	+34 91 324 40 00
Latin America	1-800-347-0178	Inside US	+1-954-255-2610
Sales Support		Outside US	+44 118 945 7360
Europe/Mid-East		Contact local distributor or call	
Distributor Operations			

Before using the unit, it must be configured to operate in the facility's network and run your applications. If you have a problem running your unit or using your equipment, contact your facility's Technical or Systems Support. If there is a problem with the equipment, they will contact the Motorola Support Center.

- Return the switch to the upright position in the place that you wish it to sit, ensuring that it is sitting evenly on all four rubber feet.
- Connect the power supply to the wall outlet.

Wall Mounting

The wall mount bracket option secures the unit to most walls using the four screws included in the mounting accessories box. The wall mounting accessories are sold separately from the switch (KT-MTDP-WS-2000-WW or KT-MTG-WS-2000-WW).

- Remove the protective rubber plugs from the switch as shown.

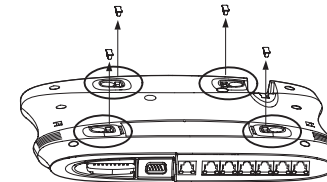

To snap into the wall mount bracket, the protective rubber plugs must be removed.

- Using the screws and wall anchors supplied in the mounting accessories box, attach the wall mount bracket to the wall as shown.



Align the RJ-45 ports on the switch with the embossed port symbols on the front of the wall mount bracket.

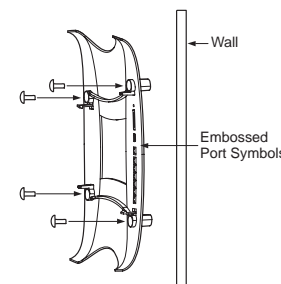

(6)

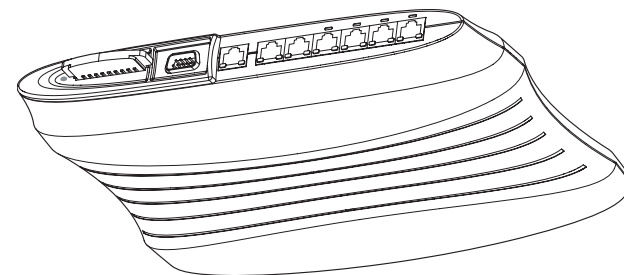

WS2000 Wireless Switch Installation Guide

Selecting a Site for Installation

The WS2000 can be installed on a flat surface, a wall, or in a rack. When selecting a site, the installer should verify the location has access to:

- A grounded outlet—preferably one that has surge protection or is protected by an uninterruptible power supply (UPS)
- The WAN connection for the switch (whether a modem, router, switch, or hub). (The wireless switch comes with a 6ft. (1.829m) patch cable for this purpose, but the installer is not required to use either that cable or stay within that distance.)
- The LAN connections for this switch (whether access port, switch, hub, or computer). Ensure this location meets optimal temperature and environmental requirements for the operation of this device (see Technical Specifications).

Desk Mounting

The desk mount option uses rubber feet which allow the unit to sit on most flat surfaces. The four (4) round rubber feet can be found in the WS2000 (main) box in a separate plastic bag.

- Turn the switch upside down so the side with the power connector is facing up.
- Connect the power supply to the switch as shown in diagram.



Do not attach the power supply to the wall outlet until installation of the switch is complete.

- Remove the backings from the four (4) rubber feet and stick them to the switch on the four circles, as shown. The feet will be right next to the four plugs.

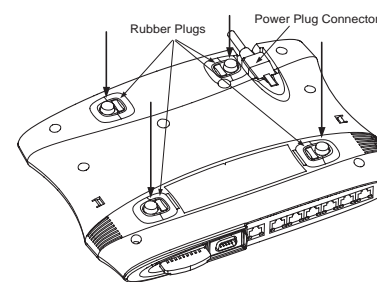

(5)

- WS2000 Wireless Switch
- Clear snap-on face plate
- Power supply with line cord
- Ethernet CAT-5 patch cable (1)
- Rubber feet for desk mount option (4)
- Rubber plugs for bottom of housing (4)
- (already installed)
- Rubber plug for CompactFlash® slot
- WS2000 Quick Installation Guide
- Wall mount bracket
- #6 mounting screws for wall mount (4)
- #6 Wall anchors for wall mount (4)
- Rack bezel
- Rack bezel Mounting screws for rack bracket and bezel
- WS2000 Quick Installation Guide

WS2000 Wireless Switch Box

Mounting Accessories Box (Sold Separately)

(KT-MTDP-WS-2000-WW or KT-MTG-WS-2000-WW)

Inspect the package contents and report any missing or damaged items to your sales representative. The packages should contain the following:

Verifying Package Contents

- Indicates a potentially dangerous condition or procedure that only Motorola-trained personnel should attempt to correct or perform.
- Care is required. Disregarding cautions can cause data loss or equipment damage.
- Indicates tips, hints and special requirements

Document Conventions

Note the following icon conventions that are used throughout the document

This guide is intended to assist the technician responsible for installing the WS2000 Wireless Switch. It assumes that the technician is familiar with basic Ethernet LAN-based networking concepts. This guide provides specifications, procedures, and guidelines to use during the installation process. It does not give site-specific installation instructions. For detailed site-specific installation procedures see the site-specific documentation derived from site survey and site network analysis.

Technical Specifications

Physical Specifications

Width	286mm (11.26in.)
Height	45mm (1.75in.)
Depth	203mm (7.99in.)
Weight	0.64kg (1.41lbs)

Power Specifications

Operating Voltage	48VDC
Operating Current	1A, Peak Current 1.6A

Environmental Specifications

Operating Temperature	0°C to 40°C (32°F to 104°F)
Storage Temperature	-40°C to 70°C (-40°F to 158°F)
Operating Humidity	10% to 85% Non-condensing
Storage Humidity	10% to 85% Non-condensing
Operating Altitude	2.4km (1.49mi)
Storage Altitude	4.6km (2.86mi)

Installation

The WS2000 can operate in various locations, allowing placement in most environments. Basic installation steps entail the following:

- Snap clear face plate (in WS2000 main box) onto the front-right side of the switch.
- Select a site (desk, wall, or rack) for installation of the wireless switch.
- Install in selected location using the instructions specifically for that location type.



Connect the wireless switch to the power supply early in the installation process for easy access to the connector; however, do not plug the power supply into a power source before installation is complete.

- Plug the wireless switch into the wall power socket.
- Lock device to desk, wall, or rack using lock port on the switch.
- Plug in WAN and LAN (Access Port) connections.
- Configure the product for your network and devices (see the WS2000 Wireless Switch System Reference available on the Motorola website).

(4)

(2)

- Before operating any equipment, review this document for any hazards associated with installation and use of the device. Also, review standard practices for preventing accidents
- Only trained and qualified personnel should install this equipment.
- Read all installation instructions and site survey reports. Verify correct equipment installation, before connecting the system to its power source.
- Remove any jewelry (rings, watches, necklaces, etc.) while installing this equipment. Install this equipment in racks with appropriate dimensions and weight allowances.
- Verify that racks are anchored and do not install in a way that can cause the equipment to tip over and break away from its mountings. Damage to the device or bodily injury can occur from equipment that was not appropriately mounted and secured.
- Verify the unit is grounded before connecting to the power source. Connect all power cords to a properly wired and grounded electrical circuit.
- Verify that any device connected to this unit is properly wired and grounded.
- Verify connecting power circuits have appropriate overload protection.
- Attach only approved power cords to the device.
- Verify the power connector is accessible at all times during the operation of the equipment.
- Verify the power circuit for the unit is grounded, can provide the required power and is not overloaded.
- Do not work with equipment power circuits in dimly lit spaces.
- Do not install this equipment or work with its power circuits during thunderstorms or weather conditions where power surges can exist.
- Verify adequate ventilation around the device and that ambient temperatures meet equipment operation specifications.
- Verify uninterruptible power sources—install the socket nearby and easily accessible to the equipment.
- For equipment that needs to be plugged in, position equipment near an easily accessible socket-outlet.



Introduction

The WS2000 Wireless Switch provides centralized management of wireless network components across a wired network infrastructure. This wireless switch can connect directly to a cable or DSL modem, and can also connect to other wide area networks through a Layer 2 or 3 device (such as a switch or router).

Product Description

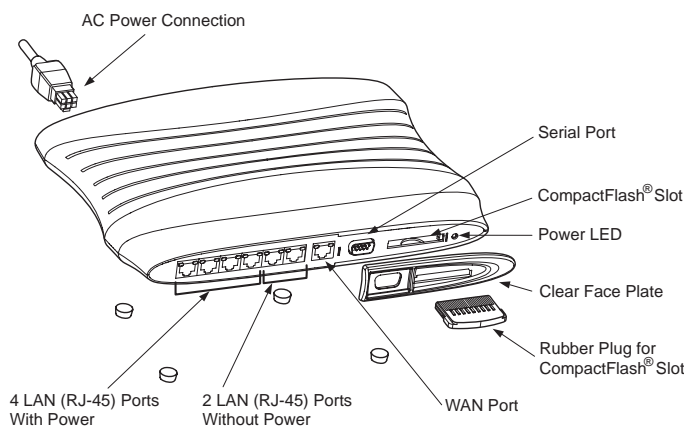

The WS2000 Wireless Switch has the following features:

- One WAN port for connection to a DSL modem, cable modem, or any other Layer 2/3 network device.
- Six LAN ports—four ports provide 802.3af Power over Ethernet (PoE) support, the other two do not provide power. Each port has two LEDs, one indicating the speed of the transmission (10Mbps/sec. or 100Mbps/sec.), the other indicating whether there is activity on the port.
- A serial port for direct access to the command-line interface from a PC. Use a DB-9 female to female null modem cable to connect to this port.
- A CompactFlash® slot provides administrative functions.

(3)

3. Connect the power supply to the switch, but not to the wall outlet.



Do not attach the power supply to the wall outlet until installation of the switch is complete.

4. Align the holes on the bottom of the switch (where the plugs used to be) with the plastic guides on the mounting bracket (circled in diagram).

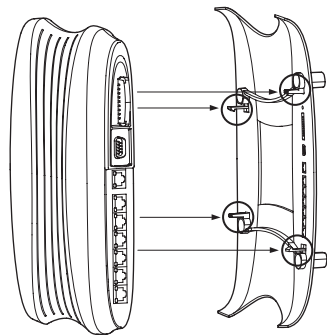

5. Push the switch into place on the bracket. You should hear a snap indicating that the switch is securely attached to the bracket.

6. Connect the power supply to the wall outlet.



The wall mount bracket is designed to allow threading of cables underneath the bracket. There is space underneath the wall mount bracket to hold cables. Cables can be place above, between, or below the attachment points.

Rack Mounting

The rack mounting option provides a 1U bracket to the switch allowing it to be mounted in a standard rack. Rack mounting accessories are sold separately from the wireless switch (KT-MTDP-WS-2000-WW or KT-MTG-WS-2000-WW). For Rack Mounting instructions please see the instructions included with the rack mounting kit.

(7)

Securing the Network Switch

The WS2000 comes with a lock port that is compatible with most locking systems. The lock port is on the rear of the switch, opposite the power connector. In order to have clear access, We suggest that you lock the wireless switch in place before you plug in WAN and LAN cables.

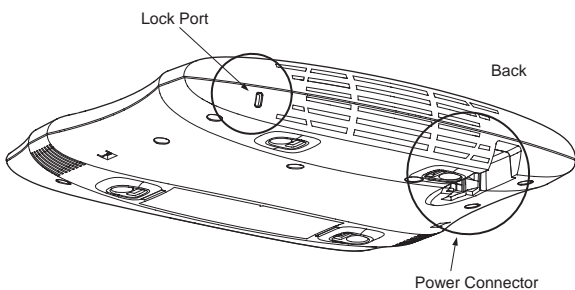

Using the CompactFlash® Slot

The WS2000 wireless switch has a CompactFlash® slot which provides administrative functions. When not being used for this purpose, the rubber plug provided with the switch should remain in the slot.

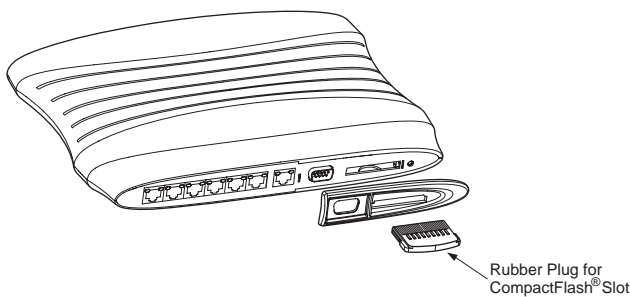

(8)

Connecting to WAN and LAN (RJ-45) Ports

The WS2000 Wireless Switch provides six LAN ports and one WAN port. LAN Ports 1-4 provide 802.3af PoE support. The WAN port is capable of hooking up to a DSL or cable modem, or to any Layer 2/3 network device

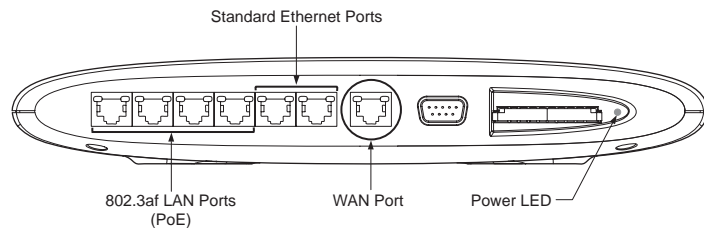

Plug devices into RJ-45 ports using standard CAT-5 patch cables.



The power LED flashes during startup and remains lit during normal operation.

Each Ethernet port has two LEDs. The LED on the left hand side of the port indicates whether the port is transmitting at 10Mbps/sec. or 100Mbps/sec. The light is off when transmitting at 10Mbit/sec. The light is on when transmitting at 100Mbps/sec. The LED on the right side indicates an Ethernet link or activity on that port. This light is on solidly when a link to a device is made. The light flashes when traffic is being transferred over the line.

The four ports that have PoE capabilities also have a PoE LED on the bottom of the port. A green light indicates 48 volts is being delivered to the power device connected to that port. A red light indicates the power device on the port is faulty. Once set to red, the light will remain red until a non-faulty device is installed. If a non-power device is connected to the port, the PoE light will remain off.

(9)

Customer Support

Motorola provides its customers with prompt and accurate customer support. Use Motorola Support Central as the primary contact for any technical problem, question or support issue involving Motorola products. If the support specialists cannot solve a problem, access to all technical disciplines becomes available for further assistance and support. Motorola Support Central responds to calls by email, telephone or fax within the time limits set forth in individual contractual agreements.

When contacting Motorola Support Central, please provide the following information:

- Serial number of unit
- Model number or product name
- Software type and version number

North American Contacts

Inside North America, contact Motorola at:

For sales and product information:

Motorola, Inc.
One Motorola Plaza
Holtsville, New York 11742-1300
Telephone: 1-631-738-2400/1-800-SCAN 234
Fax: 1-631-738-5990

For product support and service:

Support Center:
Telephone: 1-800-653-5350, +1-631-738-6213 (Outside North America)
Fax: 631-563-5410
<http://www.symbol.com/support>

International Contacts

Outside North America:
Motorola, Inc.
Winnersh Triangle, Berkshire, RG41 5TP
United Kingdom
Telephone: 0800-328-2424 (Inside UK), +44 118 945 7529 (Outside UK)

(10)

Customer Support Web Sites

Comprehensive On-line support is available at the Support Central at <http://www.symbol.com/support>. Support Central provides our customers with a wealth of information and online assistance including developer tools, software downloads, product manuals and online repair requests.

Downloads

<http://www.symbol.com/downloads/>

Manuals

<http://www.symbol.com/manuals/>

Additional Information

Obtain additional information by contacting Motorola at:
1-800-722-6234, inside North America
+1-631-738-5200, in/outside North America
<http://www.motorola.com/>

Regulatory Information

This device is approved under the Symbol Technologies brand; Symbol Technologies, Inc., is the Enterprise Mobility business of Motorola, Inc ("Motorola").

All Motorola devices are designed to be compliant with rules and regulations in locations they are sold and will be labeled as required. Local language translations are available at the following website: <http://www.symbol.com/manuals/>. Any changes or modifications not expressly approved by Motorola could void the user's authority to operate the equipment.

Wireless Devices - Country Selection

Select only the country in which you are using the device. Any other selection will make the operation of this device illegal.

(11)

Radio Frequency Interference Requirements - FCC



Note: This equipment has been tested and found to comply with the limits for a Class B digital device, pursuant to Part 15 of the FCC rules. These limits are designed to provide reasonable protection against harmful interference in a residential installation. This equipment generates, uses and can radiate

radio frequency energy and, if not installed and used in accordance with the instructions, may cause harmful interference to radio communications. However there is no guarantee that interference will not occur in a particular installation. If this equipment does cause harmful interference to radio or television reception, which can be determined by turning the equipment off and on, the user is encouraged to try to correct the interference by one or more of the following measures:

- Reorient or relocate the receiving antenna
- Increase the separation between the equipment and receiver
- Connect the equipment to an outlet on a circuit different from that to which the receiver is connected
- Consult the dealer or an experienced radio/TV technician for assistance

Radio Frequency Interference Requirements - Canada

This Class B digital apparatus complies with Canadian ICES-003. Cet appareil numérique de la classe B est conforme à la norme NMB-003 du Canada.

CE Marking and European Economic Area (EEA)

Power Supply

Use only a Motorola approved power supply output rated at 48Vdc and minimum 2.2A.

The power supply shall be Listed to UL/CSA 60950-1; and certified to IEC60950-1 and EN60950-1 with SELV outputs. Use of alternative power supply will invalidate any approval given to this device and may be dangerous.

Statement of Compliance

Motorola hereby declares that this device is in compliance with all the applicable Directives, 89/336/EEC, 73/23/EEC. A Declaration of Conformity may be obtained from: <http://www2.symbol.com/doc/>

(12)

Waste Electrical and Electronic Equipment (WEEE)



English: For EU Customers: All products at the end of their life must be returned to Motorola for recycling. For information on how to return product, go to: http://www.symbol.com/environmental_compliance

Čeština: Pro zákazníky z EU: Všechny produkty je nutné po skončení jejich životnosti vrátit společnosti Symbol k recyklaci. Informace o způsobu vrácení produktu najdete na webových stránkách: http://www.symbol.com/environmental_compliance.

Dansk: Til kunder i EU: Alle produkter skal returneres til Motorola til recirkulering, når de er udtjent. Læs oplysningerne om returnering af produkter på: http://www.symbol.com/environmental_compliance

Deutsch: Für Kunden innerhalb der EU: Alle Produkte müssen am Ende ihrer Lebensdauer zum Recycling an Motorola zurückgesandt werden. Informationen zur Rücksendung von Produkten finden Sie unter http://www.symbol.com/environmental_compliance

Eesti: EL klientidele: kõik tooted tuleb nende eluea lõppedes tagastada taaskasutamise eesmärgil Motorola'ile. Lisainformatsiooni saamiseks toote tagastamise kohta külastage palun aadressi: http://www.symbol.com/environmental_compliance

Español: Para clientes en la Unión Europea: todos los productos deberán entregarse a Motorola al final de su ciclo de vida para que sean reciclados. Si desea más información sobre cómo devolver un producto, visite: http://www.symbol.com/environmental_compliance

Ελληνικά: Για πελάτες στην Ε.Ε.: Όλα τα προϊόντα, στο τέλος της διάρκειας ζωής τους, πρέπει να επιστρέφονται στην Symbol για ανακύκλωση. Για περισσότερες πληροφορίες σχετικά με την επιστροφή ενός προϊόντος, επισκεφθείτε τη διεύθυνση http://www.symbol.com/environmental_compliance στο Διαδίκτυο.

Français: Clients de l'Union Européenne : Tous les produits en fin de cycle de vie doivent être retournés à Motorola pour recyclage. Pour de plus amples informations sur le retour de produits, consultez : http://www.symbol.com/environmental_compliance

Italiano: Per i clienti dell'UE: tutti i prodotti che sono giunti al termine del rispettivo ciclo di vita devono essere restituiti a Motorola al fine di consentirne il riciclaggio. Per informazioni sulle modalità di restituzione, visitare il seguente sito Web: http://www.symbol.com/environmental_compliance

Latviešu: ES klientiem: visi produkti pēc to kalpošanas mūža beigām ir jānogādā atpakaļ Symbol otrreizējai pārstrādei. Lai iegūtu informāciju par produktu nogādāšanu Symbol, lūdzu, skatiet: http://www.symbol.com/environmental_compliance.

(13)

Lietuvių: ES vartotojams: visi gaminiai, pasibaigus jų eksploatacijos laikui, turi būti grąžinti įtilizuoti į kompaniją „Symbol“. Daugiau informacijos, kaip grąžinti gaminį, rasite: http://www.symbol.com/environmental_compliance.

Magyar: Az EU-ban vásárlóknak: Minden tönkrement termékét a Motorola vállalatához kell eljuttatni újrahasznosítás céljából. A termék visszajuttatásának módjával kapcsolatos tudnivalókért látogasson el a http://www.symbol.com/environmental_compliance

Malti: Għal klijenti fl-UE: il-prodotti kollha li jkunu waslu fl-aħħar tal-hajja ta' l-użu tagħhom, iridu jiġu ritornati għand Symbol għar-riċiklaġġ. Għal aktar taġrif dwar kif għandek tirtorna l-prodott, jekk jogħġbok żur: http://www.symbol.com/environmental_compliance.

Nederlands: Voor klanten in de EU: alle producten dienen aan het einde van hun levensduur naar Motorola te worden teruggezonden voor recycling. Raadpleeg http://www.symbol.com/environmental_compliance voor meer informatie over het terugzenden van producten.

Polski: Klienci z obszaru Unii Europejskiej: Produkty wycofane z eksploatacji należy zwrócić do firmy Symbol w celu ich utylizacji. Informacje na temat zwrotu produktów znajdują się na stronie internetowej http://www.symbol.com/environmental_compliance.

Português: Para clientes da UE: todos os produtos no fim de vida devem ser devolvidos à Motorola para reciclagem. Para obter informações sobre como devolver o produto, visite: http://www.symbol.com/environmental_compliance

Slovenski: Za kupce v EU: vsi izdelki se morajo po poteku življenjske dobe vrniti podjetju Motorola za reciklažo. Za informacije o vračilu izdelka obiščite: http://www.symbol.com/environmental_compliance

Slovenščina: Pre zákazníkov z krajín EU: Všetky výrobky musia byť po uplynutí doby ich životnosti vrátené spoločnosti Symbol na recykláciu. Blížšie informácie o vrátení výrobkov nájdete na: http://www.symbol.com/environmental_compliance.

Suomi: Asiakkaat Euroopan unionin alueella: Kaikki tuotteet on palautettava kierrätettäväksi Motorola-yhtiöön, kun tuotetta ei enää käytetä. Lisätietoja tuotteiden palauttamisesta on osoitteessa http://www.symbol.com/environmental_compliance

Svenska: För kunder inom EU: Alla produkter som uppnått sin livslängd måste returneras till Motorola för återvinning. Information om hur du returnerar produkten finns på http://www.symbol.com/environmental_compliance

(14)